

**E3 \*NOTE  
TO ECLIPSE  
DOOR  
FABRICATOR\***

**Please ATTACH this E3  
installation instruction  
sheet (16" x 24") to door  
BEFORE SHIPPING  
TO JOB SITE.**

March 2006

**Eclipse Architectural**  
hardware systems for exterior folding doors and windows

**HARDWARE, TRACK, SILL SYSTEM AND  
WEATHERSEALING FOR  
EXTERIOR FOLDING DOORS**

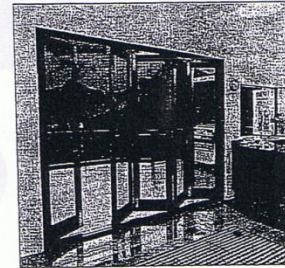

**Eclipse e3™ Installation Manual**

**\*NOTE TO FABRICATOR**

**Please make sure these instructions  
accompany finished product to the job site for  
the installation people!**

Thank you for choosing the Eclipse Architectural hardware system for exterior folding doors. The hardware, made with great care, if installed correctly will provide years of trouble free operation.

The following instructions provide guidelines for measuring and fitting the suspended folding doors complete with the Eclipse e3™ hardware system.

While this guide is as comprehensive as possible, it cannot address all eventualities, which may be encountered on site. Regardless of the quality of the hardware or construction of the panels, the most important criteria for a successful job are:

- Level, flat rough floor
- Square rough opening
- Structurally sound and unyielding rough opening header
- Clean door assembly tracks

Note: Eclipse Architectural is unable, and does not control, the actual site measuring and installation of the doors or hardware, and therefore does not assume any responsibility for the performance of the installed product.

The instructions below should be followed and adhered to. The provided below step-by-step instructions can assist any fabricator or installer. Installation is best done with more than one person.

Thank you for choosing the hardware, track, sill and weatherseal products by **Eclipse Architectural**, A division of A.K. Draft Seal Ltd, Vancouver, Canada V3K 3V5.

Email: [info@EclipseArchitectural.com](mailto:info@EclipseArchitectural.com) Website: [www.EclipseArchitectural.com](http://www.EclipseArchitectural.com)

**In A Single Direction**

**Maximum Door Weight**  
176 lbs (80 kg.)

**Maximum Door Width**  
39" (990 mm.)

**Maximum Door Height**  
120" (3048 mm.)

**Door Thickness**  
1 ¼" or 2 ¼" (44.45 or 57.15 mm.) when using E3 sill system.  
1 3/8" (34.93 mm.) to  
3" (76.2 mm.)  
when using floor channel.

**Maximum # of Doors**  
8 each way

# NORWOOD

NEVER ORDINARY

**Note:** All door panels are the same width for E3 systems.

## Eclipse e3™ Installation Manual

### SITE MEASURING

1. Check substrate of the rough opening (walls, floor and head structure) and make sure that all components are sound, suitable and ready to receive the door jambs, sill, top track / header and doors.
2. Determine the most appropriate type of fastener (i.e. screws, bolts etc) to be used for head, sill and jambs. Screws are supplied for top track installation into rough opening header.
3. Determine in and out position of the doorframe. Line up the centerline of the head track with the header beam to which it will be fastened (not applicable when using E3 sill, jamb & header system). Note that fasteners must penetrate through solid material and that offset installation may cause roll and twist of the header beam. R.O. header must not deflect more than 2mm (1/16") when carrying the weight of the doors.
4. Note – Wherever conditions are unsatisfactory, do not proceed with installation.
5. Establish and measure clear, square-opening sizes. Straight edge and level tools should be used. Ensure that all measurements follow straight lines and apply to square corner conditions.

### DOOR FRAMING (Applies To both the Bottom Floor U-Channel and E3 Sill System)

6. Construct the doorframe to the measurements taken. Attach one gasket to each end of sill before attaching jamb. Refer to fabrication drawings (Page 9 & 10).
7. Before fitting the track into the jamb head assembly, insert the Top Pivot Assembly into the track at each end, which has a pivot. The back of the pivot must be flush with the end of track.
8. Fit the extruded aluminum track to the doorframe head assembly and secure with temporary alignment screws (#8 x 12.7 mm (1/2")) placed at 1000 mm (39") on center.
9. Prepare the head of doorframe to receive installation (structural) fasteners. Pre-drill clearance holes through the track and doorframe head. The holes to be drilled at 400 mm (16") on center maximum. In addition, using 76 mm (3") spacing, drill five (5) more holes for fasteners that are needed at the end(s) where the doors stack. Top track may be predrilled for you.

**Note:** When using maximum door width & height 39" x 120" (990 mm to 3048 mm) door may exceed maximum door weight of 176 lbs (80 kg). Calculated weight check should be done.

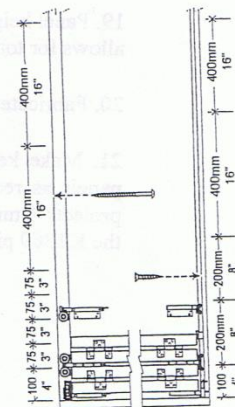
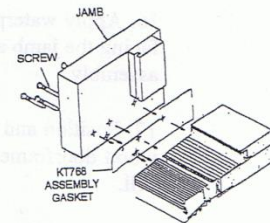
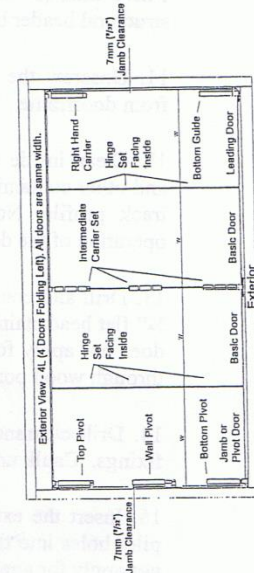
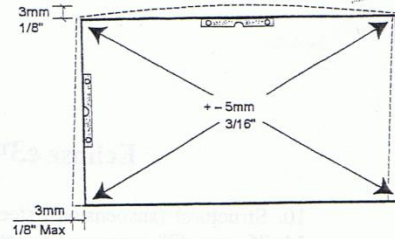

## Eclipse e3™ Installation Manual

10. Structural (suspension), steel, flat head fasteners should be at least #12 or 14x76 mm. (3" long) and penetrate by 38 mm (1½") into the rough opening's structural header beam that carries the load of the door panels.

11. Unscrew the head fasteners and remove the extruded aluminum top track from doorframe.

12. Clean inside of top track cavity and completely remove all metal shavings and other contamination. Failure to do so will embed debris into the wheels and track profile. Note that contamination of metal parts restricts the ease of operation of the doors.

13. Drill and countersink the bottom extruded aluminum track channel for #8 x ¾" flat head stainless steel screws. Place holes at 400 mm (16") on center. (This does not apply for application of the E3 Self-Draining Sill). Fasten sill to floor through wood portion of sill only. Caulk under sill accordingly.

14. Drill clearance holes in the extruded aluminum sill channel for floor pivot fixings. Caulk under pivot and seal the hole.

15. Insert the extruded aluminum sill channel into the doorframe sill, and drill pilot holes into the doorframe for the fasteners. Screw down firmly. (This does not apply for application of the E3 Self-Draining Sill).

16. Apply waterproofing sealant compound (i.e. silicone sealant) at the butt joint facing the jamb at the end of the sill track. Use sill end gasket when using E3 sill assembly.

17. Position and screw the floor pivot blocks using #8 x ¾ flat head screws for wood doorframe sill, or the #8 x 1/2" flat head screws for the E3 Self-Draining Sill.

18. Calculate panel widths using the door opening (internal) jamb-to-jamb dimension. **Note: All door panels are the same width for E3 systems.**

19. Panel heights are the vertical sill-to-head dimension less 15 mm (9/16"). This allows for top 5 mm (3/16") and bottom 10 mm (3/8") panel edge clearance.

20. Fabricate the panels to the required sizes.

21. Make kerf cuts (for weather seal gaskets) along the vertical edges of the panels as required. Position kerf cuts so the edge of the weather-seal gasket projects 1 mm (1/32") past the door face. Machine bottom of each door to hold the KT369 pile seals.

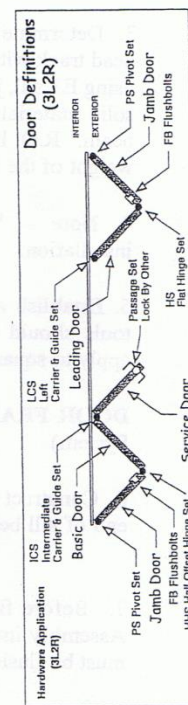
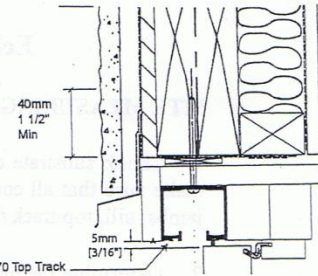

3

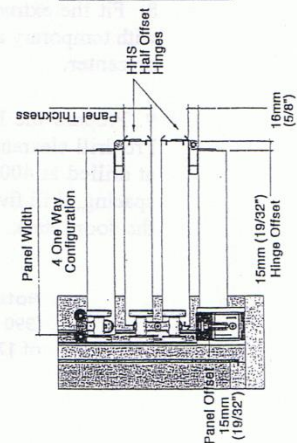
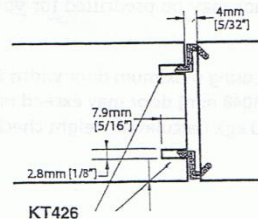

## Eclipse e3™ Installation Manual

22. In correct orientation, make a stack of the panels for each side of the door opening. Lay the panels horizontally with 15 mm spacers between. Note carefully the top and bottom of each panel and align the two ends and all sides as they will be in the final, fully open position.

23. On door stiles, mark the locations of all hinges and flaps to be fitted. Note that all carrier hinges, carrier flaps and pivot flaps are to be mounted 15 mm (9/16") from the top of each panel and 15 mm (9/16") from the bottom of each panel. Hinge sets should be mounted far enough (2 1/2" - 60 mm) to clear the doorstops on the head and sill.

24. Mark positions for and route recesses for the Flushbolts. For quick installation, use the Eclipse router bit (KTE2DBFORB). Flushbolts are machined into every odd numbered panel. (i.e. 1st, 3<sup>rd</sup>, 5<sup>th</sup> & 7th panel from each side.)

25. Fit all hinges, floor guides, intermediate and end carriers to door stiles. For proper installation, all hinge and pivot flap screw holes should be pre-drilled. A standard, self-centering bit should be used.

26. Unscrew one side of relevant hinges / carriers from stiles at each intermediate carrier location and separate panels into appropriate pairs.

### DOORFRAME INSTALLATION

27. Loose fit the doorframe into the opening (and ensure it is the right way around).

28. Position the doorframe so that the head and sill are located in the desired position as indicated above. Shim under the sill to provide for vertical support for traffic loads, and lateral support to resist wind load.

29. At the jambs, install wedges or similar items and use screws to secure temporarily the doorframe the rough opening.

30. Insert shims under the doorframe sill and ensure it is straight, level and well supported. Make sure that the doorframe sill is level or its middle part bows (concave) slightly down by no more than 2 mm. Avoid any upwards bow (convex) deformation.

31. At the top and bottom of doorframe, shim tight both jambs to the rough opening, and make the jambs plumb.

32. Check that the center of the extruded aluminum head (top) track to centre of bottom channel is 18.5 mm. (23/32"). Verify and ensure that the frame is not out of plane or twisted. Use the edge of the doorstop as the reference face.

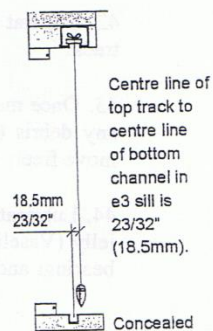
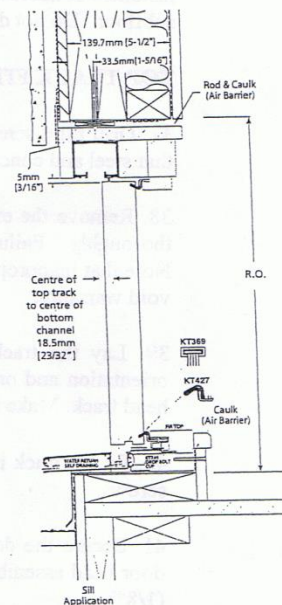
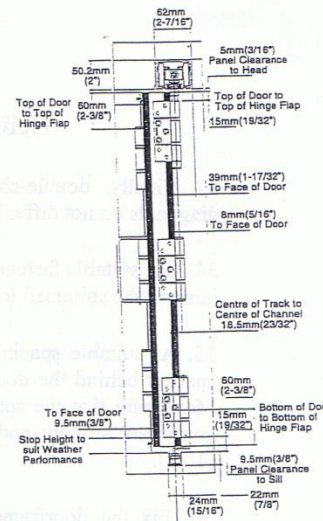

## Eclipse e3™ Installation Manual

33. Finally, double-check the doorframe square ness by verifying that the diagonals do not differ by more than 5 mm (13/64").

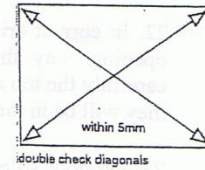

34. Use suitable fasteners and secure both the **top** and **bottom** of each doorframe jamb at the shimmed locations.

35. At suitable spacing (maximum 600 mm (24") o/c) insert additional shim-spacers behind the doorframe jambs and apply appropriate anchoring fasteners. Make sure that the spacers are of appropriate thickness and that the doorframe jambs are straight and plumb, and not bowing in or out by more than 3 mm (1/8").

36. Fix the doorframe sill to the rough opening / building structure. Apply fasteners at necessary spacing not exceeding 600 mm (24"). Fasten sill down to subfloor. Do not drill through aluminum profile of the E3 sill.

### TOP TRACK FITTING

37. Drill pilot screw holes into the structural head beam of rough opening. Note that steel and concrete structure requires additional preparation.

38. Remove the extruded aluminum track from the doorframe head and clean it thoroughly. Failure to do so damages the wheels and prevents easy operation. Note that inappropriate preparation and the resulting damage of the hardware will void warranty.

39. Lay the track in the opening to check that all parts are in the correct orientation and order. Insert the carriers and top pivot assemblies into the clean head track. Make sure carriers are facing the right way.

40. Fit the track into the doorframe head and secure with the original alignment screws.

41. Secure the doorframe head with the appropriate fasteners. Check that the door head assembly is straight, or has a slight bow upwards not exceeding 3 mm (1/8").

42. Use flat head screws supplied and secure each Top Pivot Assembly into top track.

43. Once more thoroughly clean the extruded aluminum head track and remove any debris (i.e. chips stripped from screw heads etc). Check that the carriers move freely along the full length of the track.

44. Lubricate the track and the wheels with a small quantity of white petroleum jelly (Vaseline). This will improve smooth operation, and help to preserve the bearings and track.

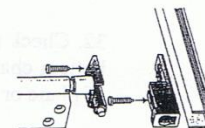
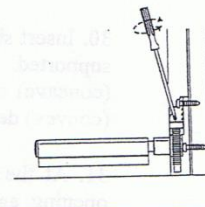
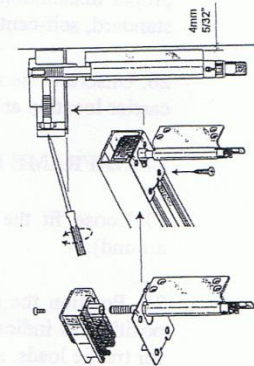

## Eclipse e3™ Installation Manual

### DOOR PANEL HANGING STARTING WITH PIVOT DOOR OR DOORS

45. Set the door panels in the open position (or 90 degrees to opening) and place them on supporting shims. The bottom edge of door panels should be level and at the sill height, or slightly above. At this point hinge flaps are not attached to door but hanging in opening.

46. Screw-secure top pivot hinge into the predrilled holes on door. Screw bottom hinge into door.

47. Close the door panel and check for a consistent gap (approximately 9/32" - 7mm) between the side jamb and the door panel. Adjust the gap by turning the top and bottom pivot adjustment screws.

48. Provide an even panel top gap of 5 mm (3/16") and an even bottom gap of 10 mm (3/8").

49. While dealing with any pivot or carrier vertical adjustment, always support the weight of the door panels with a flat / pry bar or similar tool.

50. On floor and head pivots, adjust horizontal screws so that the jamb panels are precisely plumb. Note that the door panels must be fully open to prevent damage to adjusting screws and to allow for horizontal adjustments.

51. Open door panels, adjust all the carriers vertically with a suitable screwdriver and set flush-straight the top edges of all panels.

52. Test-operate all door panels. Inspect the gaps at the end panels while the doors are closed. If the gaps are uneven, open the doors and adjust the horizontal screw on the top and bottom pivots.

### FINAL ADJUSTMENT

53. Fine-tune and adjust until the doors operate smoothly, and the gaps are even and acceptable.

54. Remove the carrier-shipping clip ("yellow") from each carrier, and turn the carrier pin engaging the SureLock™ (see the illustration).

55. Snap bottom pivot caps into place.

56. Fit Flushbolts to doors and fit drop bolt cups into sill. Make sure the gasket is fitted under the cup rim. The gasket is adhesive back both sides for sealing purposes. Caulk around rim and cup mounting holes before securing cup to sill with screws.

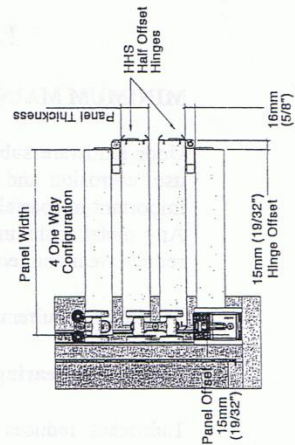

#### Using Surelock™ is simple

- 1 Components come supplied with a plastic shipping clip installed.
- 2 Insert a flat-bladed screwdriver into the slot and rotate the pin.
- 3 When correct adjustment is reached remove the shipping clip.
- 4 Surelock™ will snap into place when the blade and slot are aligned.
- 5 To readjust pull the blade down to disengage it from the slot, replace the shipping clip and rotate the pin.
- 6 Remove shipping clip after final installation adjustment.

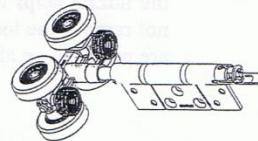
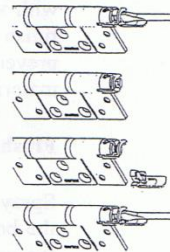

#### Surelock™ Adjustment

Surelock™ is Cenior's patented carrier pin locking system which ensures that once door heights are set at the top pivots, intermediate and end carriers, they stay set!

## Eclipse e3™ Installation Manual

### MINIMUM MAINTENANCE

Door hardware subject to wear and tear, deterioration or damage by everyday use, corrosion and other conditions. Maintenance of hardware is much more important in coastal marine or industrial and chemically aggressive environment. Any metal including stainless steel products require maintenance to prevent or reduce wear and tear or deterioration.

Minimum requirement for the maintenance of Eclipse hardware is as follows:

#### Track and Bearings

Lubricant reduces wear, improves smoothness and further protects against corrosion of the track and bearings. Note that stainless-steel bearings also require periodical cleaning and lubrication that prevents corrosion.

Use a spatula or a similar tool. Apply small amount (typically 1/4 teaspoon) of white petroleum jelly (Vaseline) or similar lubricant to the inner lip of each side of the track. Ensure that the wheels pass through the lubricant. The lubricant must be evenly distributed along the track. Apply additional lubricant around bearings.

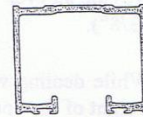

#### Hangers, Pivots and Brackets

Wipe down with warm soapy water and a soft rag, rinse clean and dry well all exposed surfaces. Apply a light spray of corrosion preventing substance such as (WD40). Remove excess and wipe with dry cloth.

#### Hinges

Use warm soapy water on a soft rag. Wipe down the exposed surfaces. Follow with wiping with a clean damp rag. Maintain the original luster of the metal finish by application of a thin film of light machine oil or the corrosion preventing spray mentioned above. Note that these materials may stain wood material and its finishes.

#### Flushbolts

Spray application of suitable lubricant such as (WD40) to the sliding pin inside the bolt and to the lock cylinder is recommended. A specialty tube attached to the nozzle helps to concentrate and direct the spray to the appropriate area. Do not remove the locks from the doors but instead use the access holes or slots that are provided on all Dropbolts.



## Eclipse e3™ Installation Manual

### Frequency

Ensure smooth operation and prevent deterioration of parts and materials. The above maintenance procedures need to be carried out as often as it is necessary. Eclipse Architectural Manufacturing recommends the following minimum frequency of the maintenance application:

- Inland environment / climate - Every six (6) months.
- Coastal marine and industrial environment / climate - Every three (3) months.

Regular maintenance is required to all hardware and materials; otherwise manufacturer's warranty may be voided.

### ARCHITECTURAL DETAIL e3™

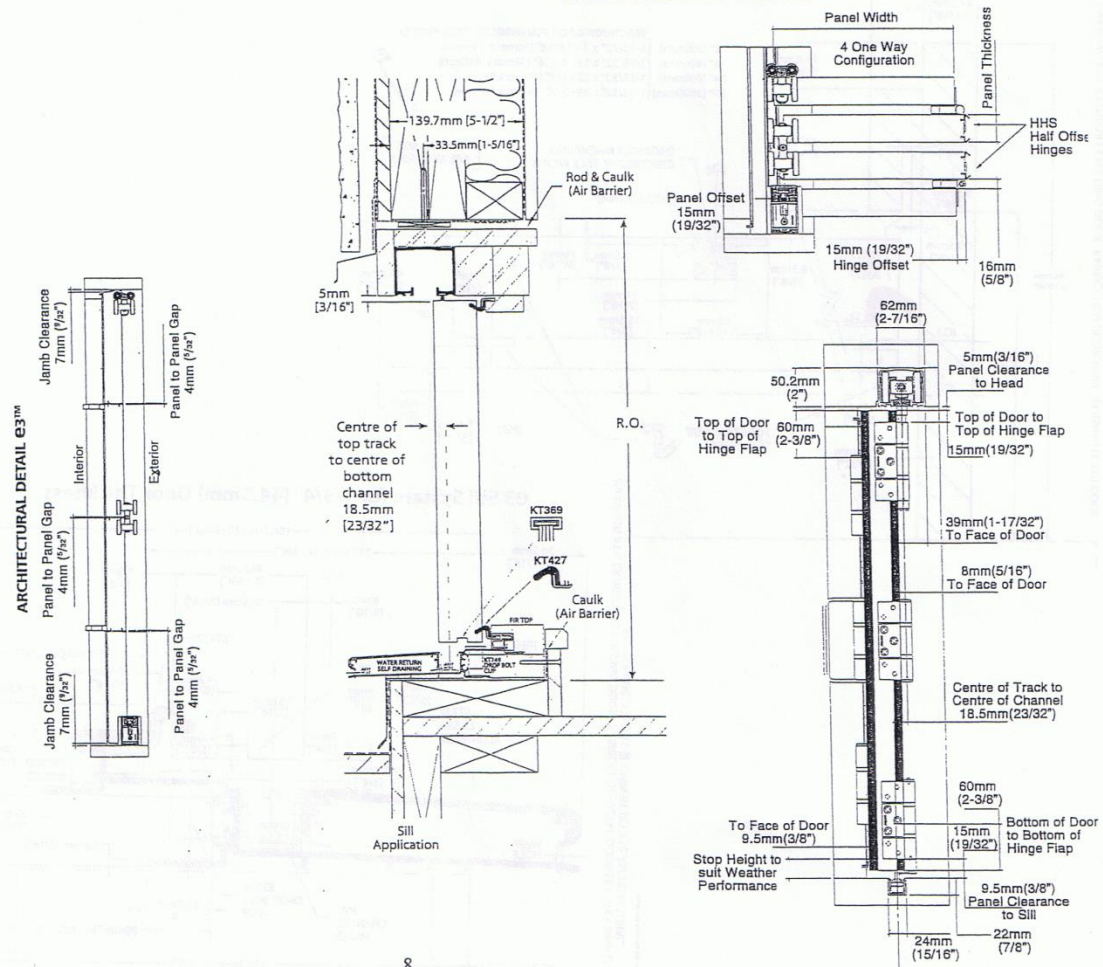

# NORWOOD

NEVER ORDINARY

## e3 Header for 1-3/4" (44.5mm) Door Thickness

DRAWING #12. EXTERIOR E3 FOLDING DOOR. FABRICATION DOOR HEAD. 44.45mm (1.75") DOOR

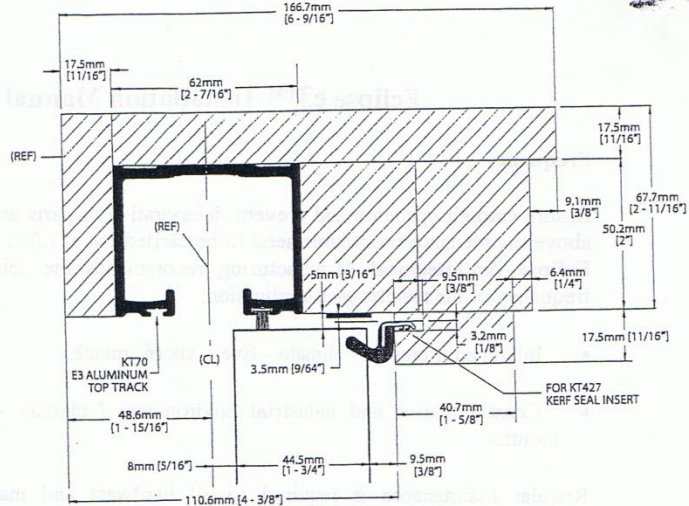

## e3 Jamb for 1-3/4" (44.5mm) Door Thickness

DRAWING #13. EXTERIOR E3 FOLDING DOOR. FABRICATION DOOR JAMB. 44.45mm (1.75") DOOR

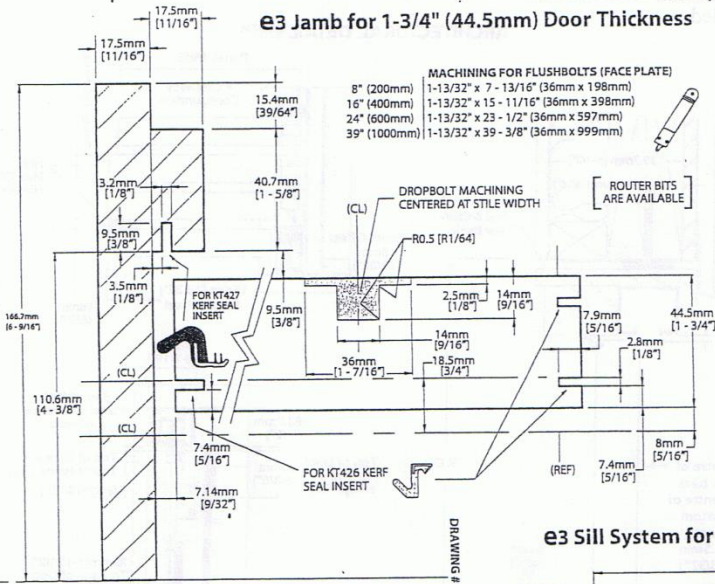

## e3 Sill System for 1-3/4" (44.5mm) Door Thickness

DRAWING #11. EXTERIOR E3 FOLDING DOOR. FABRICATION METAL DOOR SILL. 44.45mm (1.75") DOOR. SILL IS FABRICATED AS SHOWN BY ECLIPSE ARCHITECTURAL.

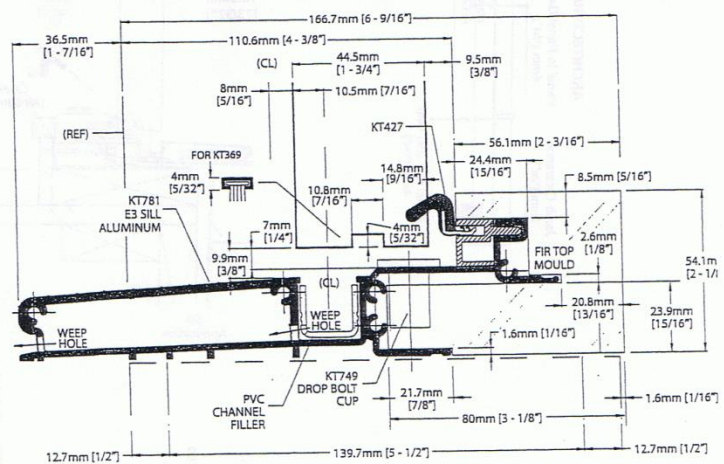

SILL IS FABRICATED AS SHOWN BY ECLIPSE ARCHITECTURAL.

# NORWOOD

NEVER ORDINARY

## e3 Header for 2-1/4" (57.2mm) Door Thickness

DRAWING #02 EXTERIOR E3 FOLDING DOOR FABRICATION DOOR HEAD, 57.15mm (2.25") DOOR

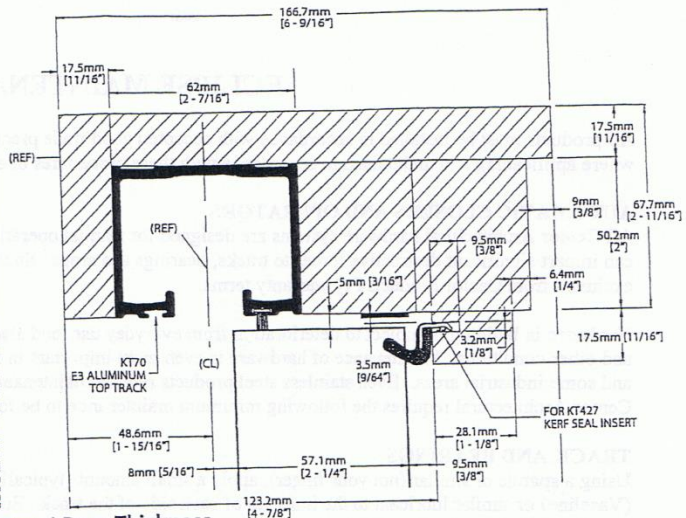

## e3 Jamb for 2-1/4" (57.2mm) Door Thickness

**MACHINING FOR FLUSH BOLTS (FACE PLATE)**  
 8" (200mm) 1-13/32" x 7 - 13/16" (36mm x 198mm)  
 16" (400mm) 1-13/32" x 15 - 11/16" (36mm x 398mm)  
 24" (600mm) 1-13/32" x 23 - 1/2" (36mm x 597mm)  
 39" (1000mm) 1-13/32" x 39 - 3/8" (36mm x 999mm)

FLUSHBOLT MACHINING CENTERED AT STILE WIDTH [ROUTER BITS ARE AVAILABLE]

DROPBOLT MACHINING CENTERED AT STILE WIDTH [RO.5 (R -1/64)]

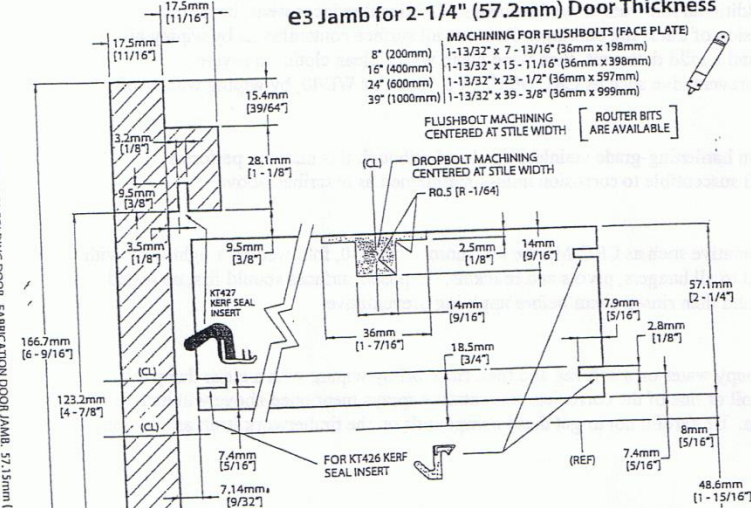

## e3 Sill System for 2-1/4" (57.2mm) Door Thickness

DRAWING #01 EXTERIOR E3 FOLDING DOOR FABRICATION METAL DOOR SILL, 57.15mm (2.25") DOOR SILL IS FABRICATED AS SHOWN BY ECUPSE ARCHITECTURAL

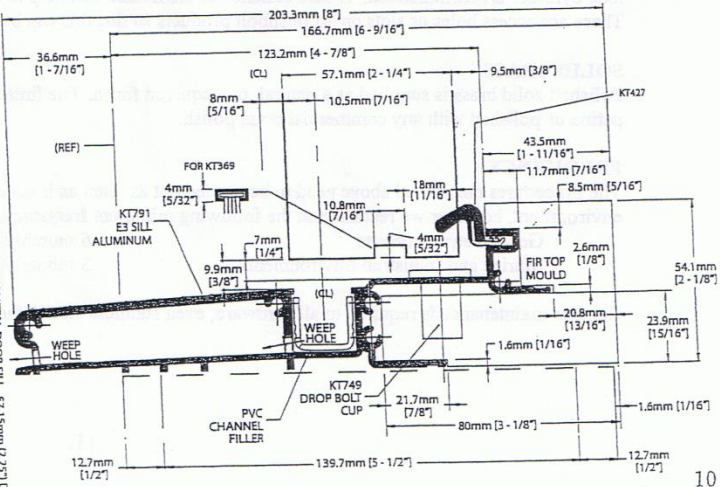

## ECLIPSE MAINTENANCE

All products must be installed in accordance with accepted good trade practice (and in accordance with supplied instructions where applicable), and maintained in accordance with these procedures or else the warranty shall be void.

### AUTOMATIC CLOSERS AND OPERATORS

All Centor Architectural hardware systems are designed for manual operation. Poorly adjusted automatic operator closers can impart significant destructive forces to tracks, bearings and stops. Such hardware used in installations is expressly excluded from Centor Products Pty warranty terms.

Hardware in building is subject to deterioration from everyday use, and also from environmental attack due to atmospheric and other conditions. Maintenance of hardware is even more important in severe environments such as coastal marine areas and some industrial areas. Even stainless steel products require maintenance to prevent deterioration in some environments. Centor Architectural requires the following minimum maintenance to be followed otherwise the warranty shall be void.

### TRACK AND BEARINGS

Using a spatula or similar (not your finger), apply a small amount (typically a ¼ teaspoon) of white petroleum jelly (Vaseline) or similar lubricant to the inner lip of each side of the track. Ensure that the wheels pass through the lubricant and it is distributed evenly along the track. Put additional lubricant around bearings. Lubricant reduces wear, improves smoothness and further protects against corrosion of track and bearings. Remove all surface contaminants by wiping all visible track surfaces with a damp soft cloth and a mild detergent, then wipe clean with a clean cloth. In severe environments, apply a thin film of corrosion preventative such as CRC Marine 66, Innox or WD40, by wiping with a soft cloth moistened with one of these products.

Stainless-steel bearings are manufactured from hardening-grade stainless-steel and although this material performs considerably better than plated steels, it is still susceptible to corrosion unless maintained as described above.

### HANGERS, PIVOTS AND BRACKETS

A light spray application of a corrosion preventative such as CRC Marine 66, Innox or WD40, followed by a light wipe with a dry cloth to remove excess, is recommended to all hangers, pivots and brackets. Exposed surfaces should first be wiped down with warm soapy water and a soft rag, and then rinsed clean before applying preventative.

### HINGES

Wipe down the visible surfaces with warm soapy water on a soft rag and then rinse off by wiping with a clean damp rag. Application of a thin film of a light machine oil or one of the corrosion preventative sprays mentioned above will help to maintain the original lustre of the metal finish. Be careful not to get these compounds on the timberwork itself as they may cause staining.

### FLUSHBOLTS

Spray application of a suitable lubricant such as CRC Marine 66, Innox or WD40 to the sliding pin inside the bolt and to the lock cylinder is recommended. A tube attached to the nozzle will help to concentrate the spray where you want it to go. There are access holes or slots on all flushbolt products so that this can be done without removing the locks from the doors.

### SOLID BRASS

Polished solid brass is supplied as a natural, unlacquered finish. The finish can either be left to develop a naturally aged patina or polished with any commercial brass polish.

### FREQUENCY

The procedures mentioned above need to be carried out as often as is necessary to prevent deterioration in the installed environment, however we recommend the following minimum frequency of application:

General environments	6 monthly
Marine and Industrial Environments	3 monthly

Regular maintenance is required to all hardware, even stainless steel; otherwise the manufacturer's warranty may be voided.

# NORWOOD

NEVER ORDINARY

## Flushbolts

## FOR ECLIPSE e2, e3, e4™ EXTERIOR OUTSWING FOLDING DOORS

security

### SYMPHONY STYLE

1" (25 mm)  
THROW LENGTH  
REGARDLESS  
OF BOLT LENGTH.



ROUND END

8" (200mm)  
or  
16" (400mm)  
or  
24" (600mm)  
or  
39" (1000mm)

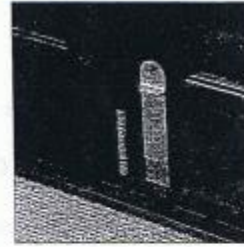

Max wind load 450kg (990lb) force  
Min door thickness 44.45mm (1-3/4")  
Bolt lengths 200/400/600/1000mm  
(8"/16"/24"/39")  
Throw length 25mm (1")  
Finishes Bright Gold Aluminum to match Polished Brass Hardware, Oil Rubbed Bronze on Aluminum to match US10B Hardware, Brushed Aluminum to match Stainless Steel Hardware

### SYMPHONY™

The flush-mounted flushbolts, rounded style and 1" (25mm) throw are designed for use with sliding and folding doors. Symphony™ will resist high winds and is rated to resist a 250kg load in Western Red Cedar and 450kg in Amoom. Eclipse can test your actual door section and provide a test certificate stating the rating achieved. The bolts are easily installed with a dedicated router bit and are available in three finishes.

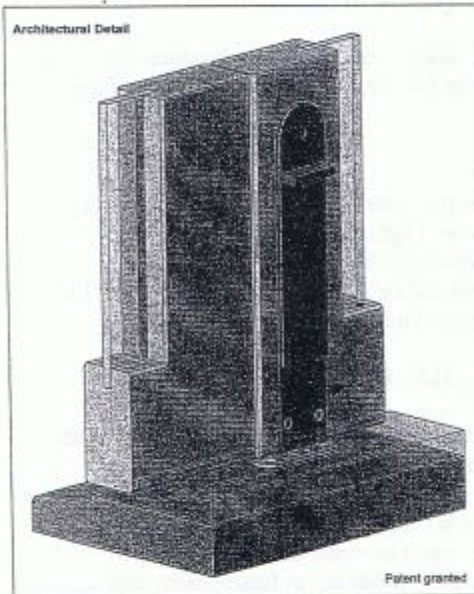

Architectural Detail

Patent granted

### Symphony™ flushbolt assembly

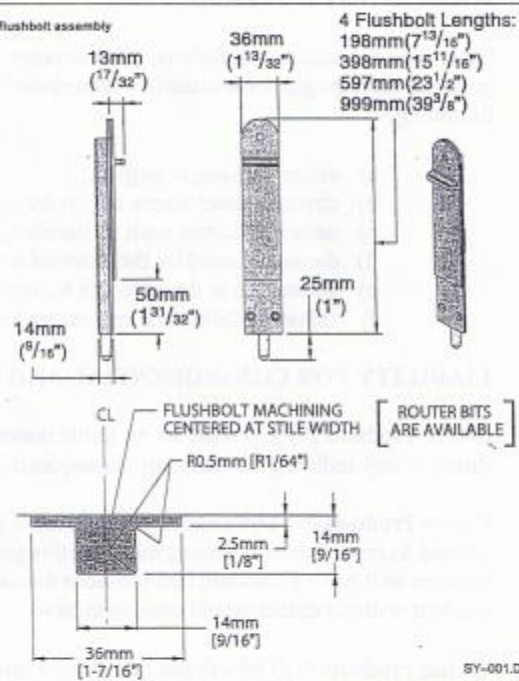

SY-001.DXF

### Machining For Flushbolts (Face Plate)

8" (200mm)	1-13/32" x 7-13/16" (36mm x 198mm)
16" (400mm)	1-13/32" x 15-11/16" (36mm x 398mm)
24" (600mm)	1-13/32" x 23-1/2" (36mm x 597mm)
39" (1000mm)	1-13/32" x 39-3/8" (36mm x 999mm)

### FLUSHBOLTS

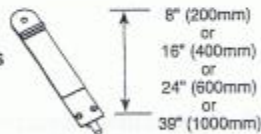

Dedicated router bits are available.

© COPYRIGHT 2004 ECLIPSE ARCHITECTURAL

Select Finish	Part Number	Description / Pc
Bright Gold Aluminum	KTDBSY200NRG	Symphony 8" (200mm) / 1" Throw, Round End
	KTDBSY400NRG	Symphony 16" (400mm) / 1" Throw, Round End
	KTDBSY600NRG	Symphony 24" (600mm) / 1" Throw, Round End
Oil Rubbed Bronze over Aluminum	KTDBSY200NRO	Symphony 8" (200mm) / 1" Throw, Round End
	KTDBSY400NRO	Symphony 16" (400mm) / 1" Throw, Round End
	KTDBSY600NRO	Symphony 24" (600mm) / 1" Throw, Round End
	KTDBSY1000NRO	Symphony 39" (1000mm) / 1" Throw, Round End
Brushed Aluminum to Match Stainless Steel	KTDBSY200NRX	Symphony 8" (200mm) / 1" Throw, Round End
	KTDBSY400NRX	Symphony 16" (400mm) / 1" Throw, Round End
	KTDBSY600NRX	Symphony 24" (600mm) / 1" Throw, Round End
	KTDBSY1000NRX	Symphony 39" (1000mm) / 1" Throw, Round End
Mill Finish	KTDBSY1000NRY	Symphony 39" (1000mm) / 1" Throw, Round End

ECLIPSE ARCHITECTURAL (A Division of A.K. Draft Seal Ltd.)