

SHUTTER DETAILS

INDEX

PRODUCT FEATURES:	PAGE 1
ELEVATIONS:	PAGE 2
SECTION DETAILS	
LOUVERS:	PAGE 3
RAISED PANELS:	PAGE 4
WOOD PLUG DETAILS:	PAGE 5
VENTING LOUVER:	PAGE 6

SPEC SHEET SHUTTERS

STANDARD FEATURES (rectangular):

- ~ Natural or prime time 2, eastern white pine
- ~ 1 5/8" thick sash
- ~ 1 9/16" stiles & rails
- ~ 1 cross rail @ 2 1/8" (optional)
- ~ Raised panel or panel with louvers.

STYLES:

Shutters are available as rectangular or camber top (center facing, left & right facing), and extended half round (center facing, left & right facing).

SPECIFICATIONS:

SASH:

- ~ 1 5/8" thick in pine (or other wood species).
- ~ 1 9/16" stiles & rails. Stiles & rails can be customized up to 5 1/2".
- ~ 2 1/8" cross rail. Cross rail can be customized up to 5 1/2".
- ~ Louvered shutters available with 2"-3 1/2" reveal
- ~ Glazing bead is putty profile.
- ~ Wood plugs are available. Please note that when wood plugs are requested, shutters are not pre-drilled to accommodate.

OPTIONS:

- ~ Venting louvers available. 1 5/8" thick sash with louvers & screen mesh installed in frame. Please contact a Norwood Sales consultant for more information.

SHUTTER ELEVATIONS

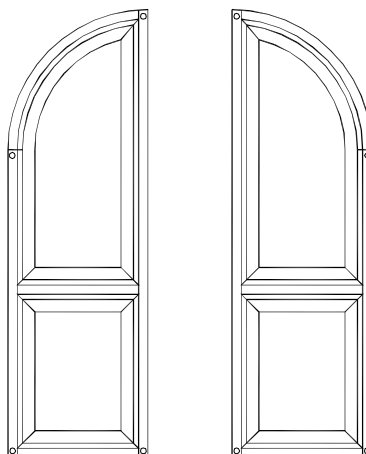
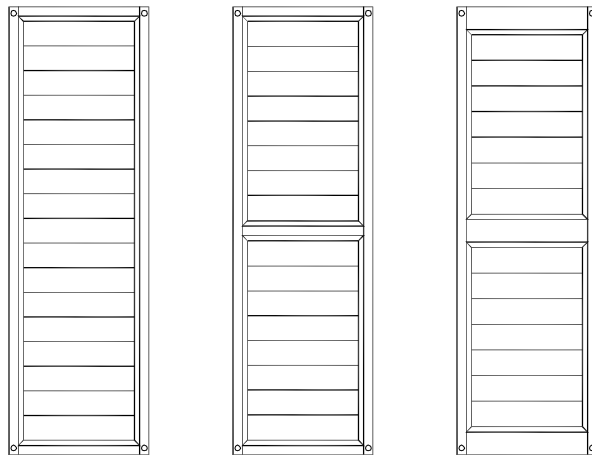
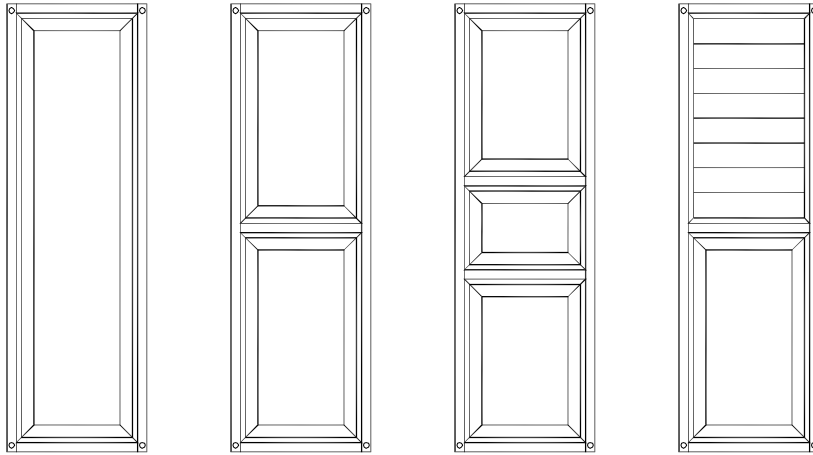

SHUTTER LOUVERS

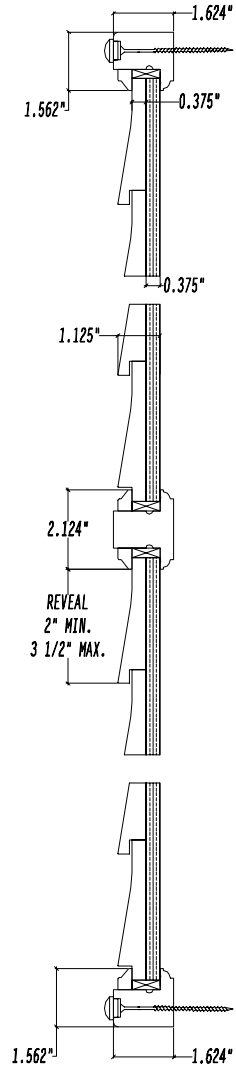
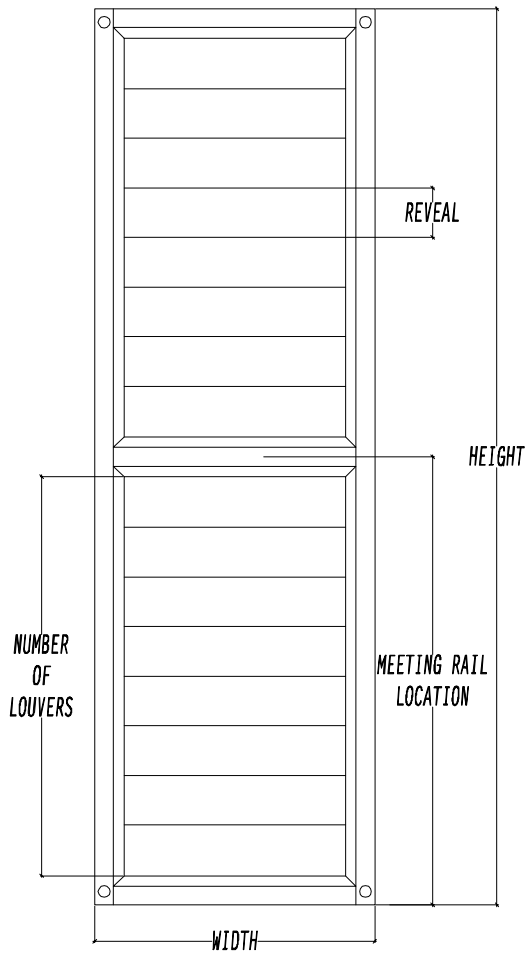

SHUTTER RAISED PANELS

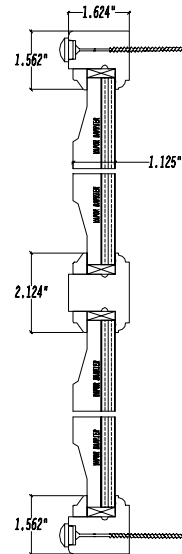
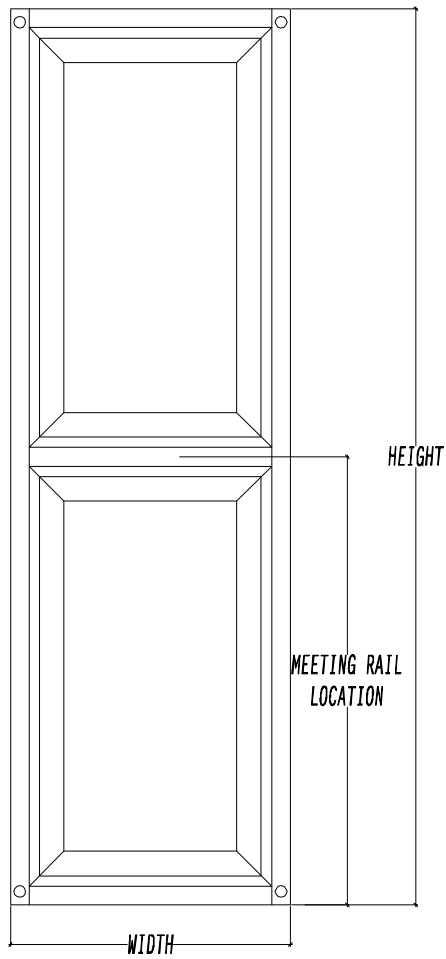

SHUTTER WOOD PLUGS

SHUTTER WOOD PLUG DETAIL

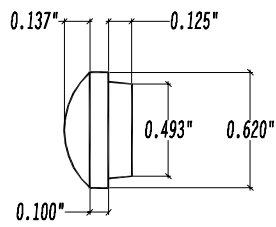

WOOD PLUG

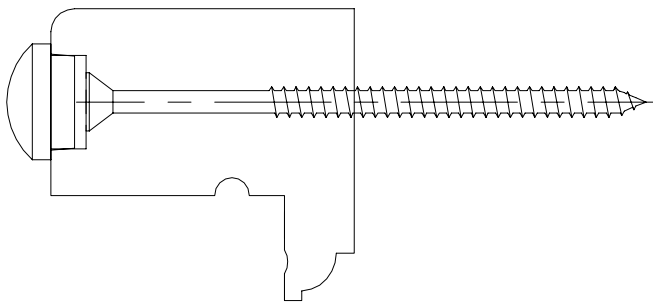
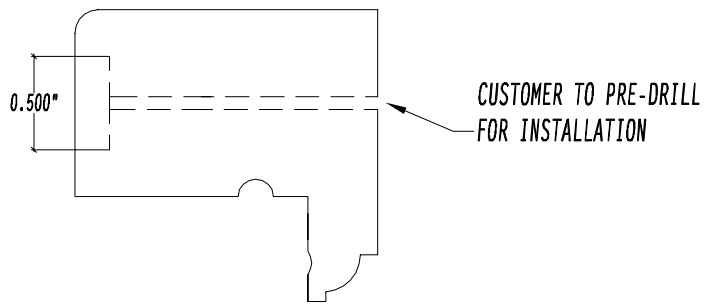

SIDE VIEW

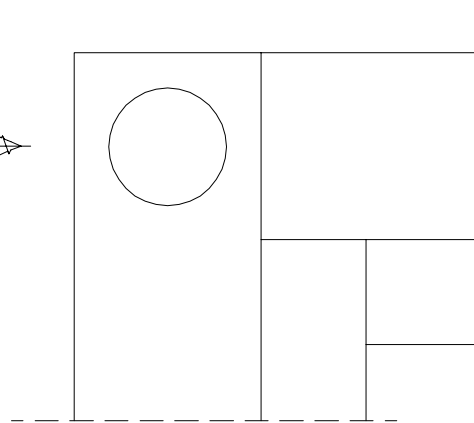

FRONT VIEW

VENTING LOUVERS

